

# OERTLI



Excellence in solid wood

**OERTLI – Alles aus  
einer starken Hand**

- Hobelmesser
- Oberfräser





## Inhalt

Hobelmesser  
Oberfräser

Seite 3 bis 16  
Seite 17 bis 52





## En Guete

Unser Aussendienst bringt Ihnen persönlich einen „zünftige Z'nüne“ pro Bestellung im Wert von 1'500 CHF.







# OERTLI Hobelmesser

... sind schärfer  
und halten länger!

Tersa

Terminus

ESTA

Centrofix

Easylock

Centrolock

Variplan

Sinus

Enshin

Streifenhobelmesser





## Tersa CS Carbonstahl

Lieferzeit: 2 Wochen  
 Aktion: 4 Stk. = - 10 %  
 8 Stk. = - 15 %  
 20 Stk. = - 20 %

Art. Nr.	Länge
TA449100	100
TA449110	110
TA449120	120
TA449125	125
TA449130	130

Art. Nr.	Länge
TA449135	135
TA449170	170
TA449180	180
TA449210	210
TA449230	230
TA449265	265
TA449300	300
TA449310	310
TA449380	380

Art. Nr.	Länge
TA449400	400
TA449410	410
TA449430	430
TA449500	500
TA449510	510
TA449522	520
TA449610	610
TA449630	630
TA449636	635

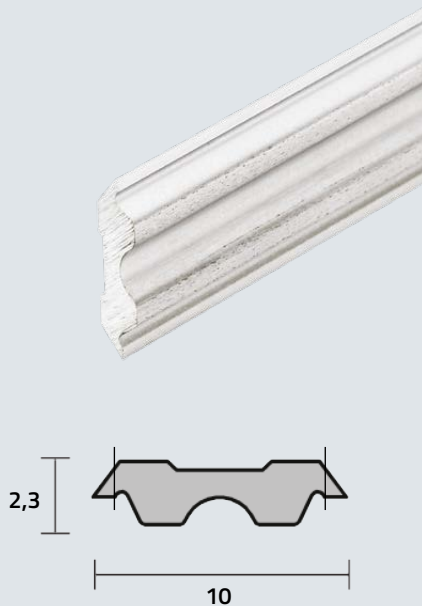

## Tersa HS Schnellarbeitsstahl



Lieferzeit: 1 Woche  
 Aktion: 4 Stk. = - 15 %  
 8 Stk. = - 25 %  
 20 Stk. = - 35 %

Art. Nr.	Länge
TA449062	60
TA449072	70
TA449082	80
TA449092	90
TA449102	100
TA449112	110
TA449122	120
TA449132	130
TA449137	135
TA449142	140
TA449152	150
TA449162	160
TA449172	170
TA449182	180
TA449187	185
TA449192	190
TA449197	195
TA449202	200
TA449212	210

Art. Nr.	Länge
TA449222	220
TA449232	230
TA449237	235
TA449242	240
TA449252	250
TA449262	260
TA449272	270
TA449282	280
TA449292	290
TA449302	300
TA449312	310
TA449322	320
TA449332	330
TA449342	340
TA449352	350
TA449362	360
TA449372	370
TA449382	380
TA449392	390
TA449402	400
TA449412	410
TA449422	420
TA449432	430

Art. Nr.	Länge
TA449442	440
TA449452	450
TA449462	460
TA449472	470
TA449482	480
TA449492	490
TA449502	500
TA449512	510
TA449520	520
TA449524	530
TA449542	540
TA449552	550
TA449562	560
TA449572	570
TA449582	580
TA449592	590
TA449602	600
TA449612	610
TA449622	620
TA449632	630
TA449642	640
TA449652	650
TA449662	660

Art. Nr.	Länge
TA449672	670
TA449682	680
TA449692	690
TA449702	700
TA449712	710
TA449722	720

Art. Nr.	Länge
TA449732	730
TA449742	740
TA449752	750
TA449762	760
TA449772	770
TA449782	780

Art. Nr.	Länge
TA449792	790
TA449802	800
TA449812	810
TA449822	820
TA449832	830

## Tersa HS-M+ Schnellarbeitsstahl M+

Lieferzeit: 1 Wochen  
 Aktion: 4 Stk. = - 15 %  
 8 Stk. = - 25 %  
 20 Stk. = - 35 %

Art. Nr.	Länge
TA449063	60
TA449073	70
TA449083	80
TA449093	90
TA449103	100
TA449113	110
TA449119	115
TA449123	120
TA449128	125
TA449133	130
TA449143	140
TA449153	150
TA449163	160
TA449173	170
TA449183	180
TA449193	190
TA449203	200
TA449213	210
TA449223	220
TA449226	228
TA449233	230
TA449243	240
TA449253	250
TA449256	255

Art. Nr.	Länge
TA449263	260
TA449268	265
TA449273	270
TA449283	280
TA449293	290
TA449303	300
TA449313	310
TA449323	320
TA449333	330
TA449343	340
TA449353	350
TA449363	360
TA449373	370
TA449383	380
TA449393	390
TA449403	400
TA449413	410
TA449423	420
TA449433	430
TA449443	440
TA449446	450
TA449463	460
TA449473	470
TA449483	480
TA449493	490
TA449503	500
TA449513	510
TA449523	520

Art. Nr.	Länge
TA449525	530
TA449543	540
TA449553	550
TA449563	560
TA449573	570
TA449583	580
TA449593	590
TA449603	600
TA449613	610
TA449623	620
TA449633	630
TA449643	640
TA449653	650
TA449663	660
TA449673	670
TA449683	680
TA449693	690
TA449703	700
TA449713	710
TA449723	720
TA449733	730
TA449743	740
TA449753	750
TA449763	760
TA449773	770
TA449783	780
TA449793	790
TA449803	800

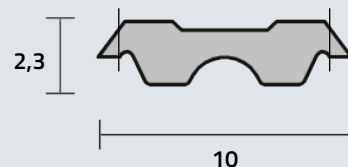

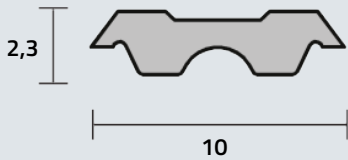

## Tersa HW Hartmetall

Lieferzeit: 2 Wochen  
 Aktion: 4 Stk. = - 10 %  
 8 Stk. = - 15 %  
 20 Stk. = - 20 %

Art. Nr.	Länge
TA449061	60
TA449071	70
TA449081	80
TA449091	90
TA449101	100
TA449111	110
TA449121	120
TA449131	130
TA449136	135
TA449141	140
TA449151	150

Art. Nr.	Länge
TA449161	160
TA449171	170
TA449181	180
TA449186	185
TA449191	190
TA449201	200
TA449211	210
TA449221	220
TA449231	230
TA449236	235
TA449241	240
TA449251	250
TA449261	260
TA449271	270
TA449281	280

Art. Nr.	Länge
TA449291	290
TA449301	300
TA449311	310
TA449321	320
TA449331	330
TA449341	340
TA449351	350
TA449361	360
TA449371	370
TA449381	380
TA449391	390
TA449401	400
TA449411	410
TA449431	430
TA449631	630

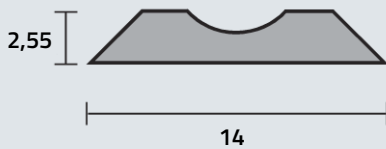

## Terminus HS Schnellarbeitsstahl

Lieferzeit: 2 Wochen  
 Aktion: 4 Stk. = - 15 %  
 8 Stk. = - 25 %  
 20 Stk. = - 35 %



Art. Nr.	Länge
TB400100	50
TB400101	60
TB400102	80
TB400103	100
TB400104	110
TB400105	120
TB400106	130
TB400107	136
TB400108	140
TB400109	150
TB400110	160
TB400111	170
TB400112	180
TB400113	190

Art. Nr.	Länge
TB400114	200
TB400115	210
TB400116	220
TB400117	230
TB400118	240
TB400119	250
TB400121	260
TB400122	270
TB400123	275
TB400124	280
TB400125	300
TB400126	310
TB400128	350
TB400129	360
TB400130	400
TB400131	410
TB400132	420
TB400133	430

Art. Nr.	Länge
TB400134	450
TB400135	480
TB400136	500
TB400137	510
TB400138	520
TB400139	530
TB400140	610
TB400141	620
TB400142	630
TB400143	640
TB400144	650
TB400146	810



## Terminus HW Hartmetall

Lieferzeit: 2 Wochen

Aktion: 4 Stk. = - 15 %  
8 Stk. = - 25 %  
20 Stk. = - 35 %

Art. Nr.	Länge
TB401100	50
TB401101	60
TB401102	80
TB401103	100
TB401104	110
TB401105	120
TB401106	130
TB401107	136
TB401108	140
TB401109	150
TB401110	160
TB401111	170
TB401112	180

Art. Nr.	Länge
TB401113	190
TB401114	200
TB401115	210
TB401116	220
TB401117	230
TB401118	240
TB401119	250
TB401120	255
TB401121	260
TB401122	270
TB401123	275
TB401124	280
TB401125	300
TB401126	310
TB401127	330
TB401128	350
TB401129	360

Art. Nr.	Länge
TB401130	400
TB401131	410
TB401132	420
TB401133	430
TB401134	450
TB401135	480
TB401136	500
TB401137	510
TB401138	520
TB401139	530
TB401140	610
TB401141	620
TB401142	630
TB401143	640
TB401144	650

## ESTA SP Spezialstahl

Lieferzeit: 1 Woche

Aktion: 4 Stk. = - 15 %  
8 Stk. = - 25 %  
20 Stk. = - 35 %

Art. Nr.	Länge
TL104299	60
TL104300	80
TL104301	100
TL104302	110
TL104303	115
TL104304	120
TL104305	125
TL104306	130
TL104307	136
TL104308	140
TL104309	150
TL104310	150
TL104311	160

Art. Nr.	Länge
TL104312	161
TL104313	170
TL104314	170
TL104315	180
TL104316	190
TL104317	190
TL104318	200
TL104319	200
TL104320	203
TL104321	205
TL104322	208
TL104323	210
TL104324	210
TL104325	210
TL104326	220
TL104327	230
TL104328	240

Art. Nr.	Länge
TL104329	245
TL104330	248
TL104331	250
TL104332	260
TL104333	260
TL104334	260
TL104335	263
TL100110	280
TL104336	280
TL104337	300
TL100059	300
TL104338	305
TL101933	310
TL104339	310
TL104061	310
TL104340	320
TL104341	320

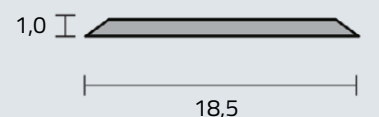
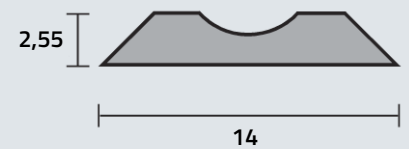

Art. Nr.	Länge
TL104342	320
TL104343	330
TL104344	350
TL104345	350
TL104346	360
TL104347	360
TL104348	400
TL104349	400
TL104350	410
TL104351	410
TL101943	410
TL104352	410

Art. Nr.	Länge
TL104353	420
TL104354	430
TL104355	450
TL104356	460
TL104357	500
TL101318	510
TL104358	510
TL104098	510
TL104359	520
TL104360	530
TL104361	530
TL104362	600

Art. Nr.	Länge
TL104363	600
TL104364	610
TL104365	620
TL104366	630
TL104367	635
TL102388	640
TL104368	650
TL104369	660
TL104370	710
TL104371	740
TL104372	760
TL104373	810

## ESTA CO Chromstahl

Lieferzeit: 1 Wochen  
 Aktion: 4 Stk. = - 15 %  
 8 Stk. = - 25 %  
 20 Stk. = - 35 %

Art. Nr.	Länge
TL104374	60
TL104375	80
TL104376	100
TL104377	115
TL104378	120
TL104379	130
TL104380	136
TL104381	140
TL104382	150
TL104383	150
TL104384	160
TL104385	161
TL104386	170
TL104387	170
TL104388	180
TL104389	186
TL104390	190
TL104391	200
TL104392	200
TL104393	203

Art. Nr.	Länge
TL104394	205
TL104395	208
TL104396	210
TL104397	210
TL104398	230
TL104399	240
TL104400	245
TL104401	248
TL104402	250
TL104403	260
TL104404	260
TL104405	263
TL104406	280
TL104407	280
TL104408	300
TL104409	300
TL104410	310
TL104411	310
TL104412	310
TL104413	310
TL104414	320
TL104415	330
TL104416	350
TL104417	350
TL104418	360

Art. Nr.	Länge
TL104419	400
TL104420	400
TL104421	410
TL104422	410
TL104423	410
TL104424	410
TL104425	430
TL104426	450
TL104427	460
TL104428	500
TL104429	510
TL104430	510
TL104431	520
TL104432	530
TL104433	600
TL104434	610
TL104435	630
TL104436	635
TL104437	640
TL104438	650
TL104439	660
TL104440	710
TL104441	760
TL104442	810

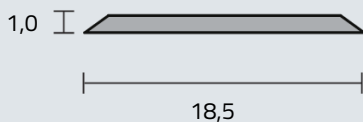





## Centrofix HS Schnellarbeitsstahl

Lieferzeit: 2 Wochen

Aktion: 4 Stk. = - 10 %  
8 Stk. = - 15 %  
20 Stk. = - 20 %

Art. Nr.	Länge
TB400000	60
TB400002	80
TB400004	100
TB400005	110
TB400006	120
TB400007	130
TB400008	140
TB400009	150
TB400010	160
TB400011	170
TB400012	180
TB400013	190
TB400014	200
TB400015	210
TB400016	220
TB400017	230
TB400018	240

Art. Nr.	Länge
TB400019	250
TB400020	260
TB400021	270
TB400022	280
TB400024	300
TB400025	310
TB400026	320
TB400027	330
TB400029	350
TB400030	360
TB400032	380
TB400034	400
TB400035	410
TB400036	420
TB400037	430
TB400039	450
TB400040	460
TB400042	480
TB400044	500
TB400045	510
TB400046	520

Art. Nr.	Länge
TB400047	530
TB400048	540
TB400049	550
TB400054	600
TB400055	610
TB400056	620
TB400057	630

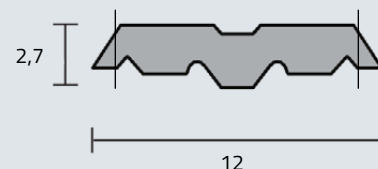

## Easylock HS Schnellarbeitsstahl

Lieferzeit: 2 Wochen

Aktion: 4 Stk. = - 10 %  
8 Stk. = - 15 %  
20 Stk. = - 20 %

Art. Nr.	Länge
TB400200	170
TB400201	285

## Easylock HW Hartmetall

Lieferzeit: 2 Wochen

Aktion: 4 Stk. = - 10 %  
8 Stk. = - 15 %  
20 Stk. = - 20 %

Art. Nr.	Länge
TB401200	170
TB401201	285

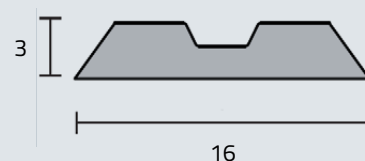
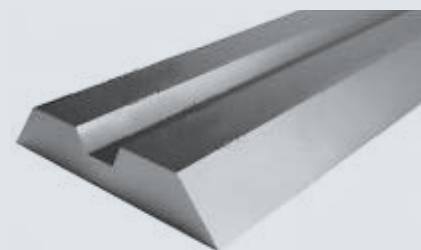

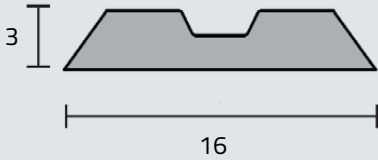
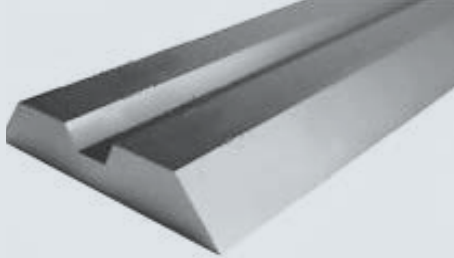

## Centrolock HS Schnellarbeitsstahl

Lieferzeit: 2 Wochen  
 Aktion: 4 Stk. = - 10 %  
 8 Stk. = - 15 %  
 20 Stk. = - 20 %

Art. Nr.	Länge
TA450540	80
TA450541	100

Art. Nr.	Länge
TA450542	130
TA450543	150
TA450544	170
TA450545	180
TA450546	190
TA450547	210

Art. Nr.	Länge
TA450548	230
TA450549	240
TA450550	260
TA450551	270
TA450552	310
TA450553	460

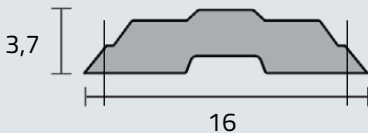
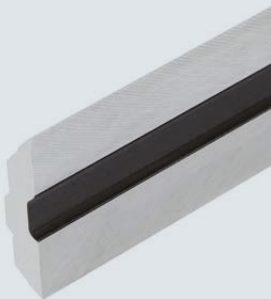

## Variplan HS Schnellarbeitsstahl

Lieferzeit: 2 Wochen  
 Aktion: 4 Stk. = - 10 %  
 8 Stk. = - 15 %  
 20 Stk. = - 20 %

Art. Nr.	Länge
TB400300	60
TB400301	80
TB400302	100
TB400303	120
TB400304	130
TB400305	136

Art. Nr.	Länge
TB400306	150
TB400307	170
TB400308	180
TB400309	190
TB400310	210
TB400311	230
TB400312	240
TB400313	400
TB400314	410
TB400315	420
TB400316	430

Art. Nr.	Länge
TB400317	500
TB400318	510
TB400319	520
TB400320	530
TB400321	540
TB400322	600
TB400323	610
TB400324	630
TB400325	640





## Variplan HW Hartmetall

Variplan HW

Lieferzeit: 2 Wochen

Aktion: 4 Stk. = - 10 %

8 Stk. = - 15 %

20 Stk. = - 20 %

Art. Nr.	Länge
TB401300	60
TB401301	80
TB401302	100
TB401303	120
TB401304	130
TB401305	136

Art. Nr.	Länge
TB401306	150
TB401307	170
TB401308	180
TB401309	190
TB401310	210
TB401311	230
TB401312	240
TB401313	400
TB401314	410
TB401315	4220
TB401316	430

Art. Nr.	Länge
TB401317	500
TB401318	510
TB401319	520
TB401320	530
TB401321	540
TB401322	600
TB401323	610
TB401324	630
TB401325	640

## Sinus HS-TRI Schnellarbeitsstahl TRI

Lieferzeit: 1 Wochen

Aktion: 4 Stk. = - 15 %

8 Stk. = - 25 %

20 Stk. = - 35 %

Art. Nr.	Länge
TA469707	60
TA469708	80
TA469710	100
TA469712	120
TA469713	130
TA469736	136
TA469714	140
TA469715	150
TA469716	160
TA469717	170

Art. Nr.	Länge
TA469718	180
TA469786	186
TA469719	190
TA469720	200
TA469721	210
TA469722	220
TA469723	230
TA469724	240
TA469725	250
TA469726	260
TA469727	270
TA469730	300
TA469731	310
TA469732	320

Art. Nr.	Länge
TA469740	400
TA469741	410
TA469743	430
TA469746	460
TA469750	500
TA469751	510
TA469761	610
TA469763	630
TA469764	640
TA469770	700
TA469771	710
TA469798	1350

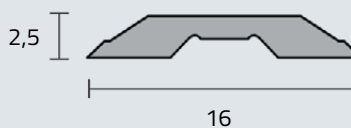
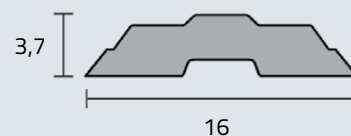
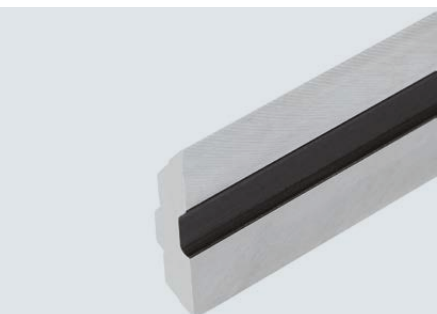

## Sinus HW Hartmetall

Lieferzeit: 1 Wochen  
 Aktion: 4 Stk. = - 15 %  
 8 Stk. = - 25 %  
 20 Stk. = - 35 %

Art. Nr.	Länge
TA469945	60
TA469950	80
TA469951	100
TA469801L106	106

Art. Nr.	Länge
TA469952	120
TA469953	130
TA469954	140
TA469955	150
TA469956	160
TA469957	180
TA469966	190
TA469958	200
TA469959	210

Art. Nr.	Länge
TA469960	220
TA469961	230
TA469962	240
TA469963	250
TA469964	260
TA469967	270
TA469965	300
TA469801L310	310

## Enshin HS-beschichtet Hartstoffbeschichtung

Lieferzeit: 1 Wochen  
 Aktion: 4 Stk. = - 15 %  
 8 Stk. = - 25 %  
 20 Stk. = - 35 %

Art. Nr.	Länge
TB450002	64
TA466633	80

Art. Nr.	Länge
TA466629	115
TA466630	130

Art. Nr.	Länge
TA466631	180
TA466632	230

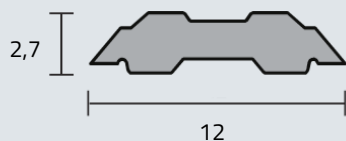

## Enshin HW Hartmetall

Lieferzeit: 1 Wochen  
 Aktion: 4 Stk. = - 15 %  
 8 Stk. = - 25 %  
 20 Stk. = - 35 %

Art. Nr.	Länge
TA466644	60
TA466645	80
TA466646	100

Art. Nr.	Länge
TA466640	130
TA466647	150
TA466641	180

Art. Nr.	Länge
TA466642	230
TB450005	270
TA466643	300



## B=35 HS-beschichtet Hartstoffbeschichtung

Lieferzeit: 5 Wochen

Aktion: 4 Stk. = - 10 %  
8 Stk. = - 15 %  
20 Stk. = - 20 %

Art. Nr.	Länge
TA450458	100
TA450459	150

Art. Nr.	Länge
TA450460	230
TA450461	260

Art. Nr.	Länge
TA450462	635

## B=30 HS-beschichtet Hartstoffbeschichtung

Lieferzeit: 5 Wochen

Aktion: 4 Stk. = - 10 %  
8 Stk. = - 15 %  
20 Stk. = - 20 %

Art. Nr.	Länge
TA450450	100
TA450451	130
TA450452	150
TA450453	180

Art. Nr.	Länge
TA450454	230
TB450000	240
TA450455	260
TA450456	310

Art. Nr.	Länge
TB450001	610
TA450457	635

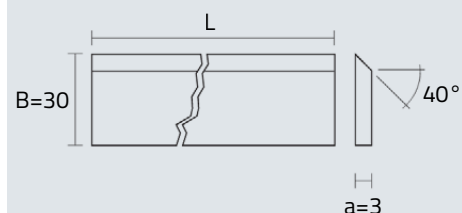
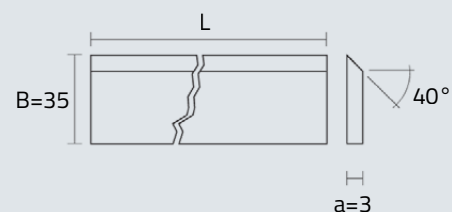

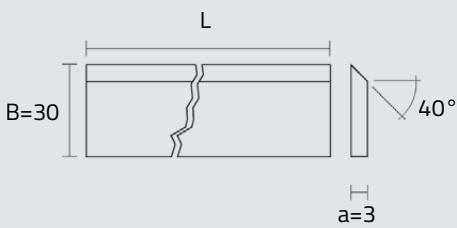

## B=30 VHW Vollhartmetall

Lieferzeit: 3 Wochen  
 Aktion: 4 Stk. = - 10 %  
 8 Stk. = - 15 %  
 20 Stk. = - 20 %

Art. Nr.	Länge
TA450512	80
TA450514	100
TA450516	120
TA450518	130

Art. Nr.	Länge
TA450519	140
TA450520	150
TA450524	180
TA450525	185
TA450526	20
TA450528	210
TA450529	225
TA450530	230

Art. Nr.	Länge
TA450532	240
TA450534	260
TA450536	270
TA450537	300
TA450538	310
TA450539	330

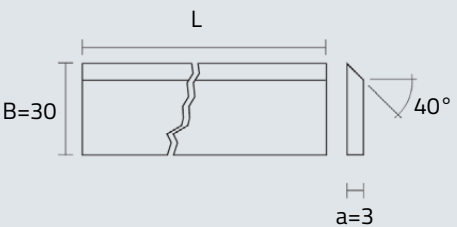

## B=30 HW Hartmetall

Lieferzeit: 3 Wochen  
 Aktion: 4 Stk. = - 10 %  
 8 Stk. = - 15 %  
 20 Stk. = - 20 %

Art. Nr.	Länge
TA450152	80
TA450154	100
TA450156	120
TA450158	130
TA450160	150
TA450162	160
TA450164	180

Art. Nr.	Länge
TA450166	200
TA450168	210
TA450170	230
TA450172	250
TA450174	260
TA450176	300
TA450178	310
TA450180	350
TA450181	360
TA450182	400
TA450184	410

Art. Nr.	Länge
TA450186	450
TA450188	460
TA450190	500
TA450192	510
TA450194	550
TA450196	600
TA450198	610
TA450200	640
TA450202	680
TA450204	710
TA450206	810

## B=30 HS Super Rapid Schnellarbeitsstahl

Lieferzeit: 1 Wochen

Aktion: 4 Stk. = - 15 %

8 Stk. = - 25 %

20 Stk. = - 35 %

Art. Nr.	Länge
TA450012	80
TA450013	90
TA450014	100
TA450015	110
TA450016	120
TA450018	130
TA450019	140
TA450020	150
TA450022	160
TA450023	170
TA450024	180
TA450027	190
TA450025	200
TA450028	210
TA450029	220

Art. Nr.	Länge
TA450030	230
TA450031	240
TA450032	250
TA450034	260
TA450033	270
TA450035	280
TA450037	290
TA450036	300
TA450038	310
TA450039	320
TA450043	330
TA450047	340
TA450040	350
TA450049	360
TA450051	370
TA450055	380
TA450057	390
TA450041	400
TA450044	410

Art. Nr.	Länge
TA450045	430
TA450046	450
TA450048	460
TA450050	500
TA450052	510
TA450053	530
TA450054	550
TA450056	600
TA450058	610
TA450059	620
TA450070	630
TA450060	640
TA450062	650
TA450061	660
TA450064	710
TA450065	770
TA450066	810

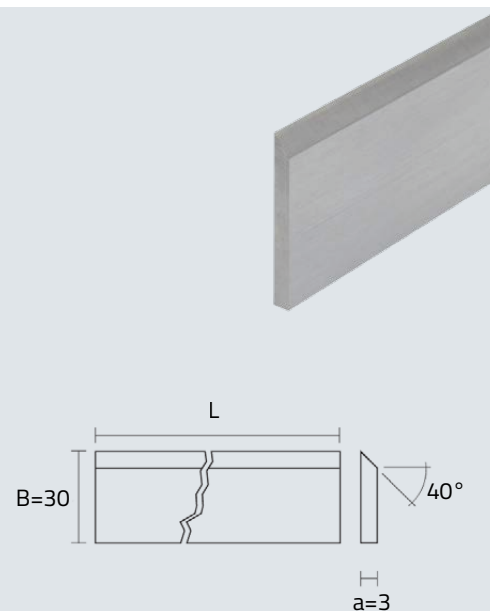





# OERTLI Oberfräser

## ...sind schärfer und halten länger!

VHW Schruppfräser TURBEX ECOLine	18	HW Griffmuldenfräser	32
HW Nutfräser gerade	18	WS Nutfräser gerade	32
HW Nutfräser gerade ohne Zentrumschneide	18	WS Bündigfräser mit Kugellager unten	34
HW Nutfräser gerade ohne Zentrumschneide	19	WS Bündigfräser mit Kugellager am Schaft	35
HW Nutfräser gerade mit Zentrumschneide	20	WS Fasfräser mit Kugellager	36
HW Nutfräser gerade mit Zentrumschneide	21	WS Abrundfräser, Körper ohne WS und Kugellager	37
HW Nutfräser Typ FESTOOL DOMINO	23	WS Abrund- / Viertelstabfräser	38
HW Bündigfräser mit Kugellager am Schaft	23	WS Bündig- / Fasfräser	39
HW Bündigfräser mit Kugellager	23	WS Falzfräser mit Kugellager	40
HW Bündigfräser mit Achswinkel Kugellager unten	24	HW / WS Nutfräser Planet ohne Kugellager	41
HW Fasfräser mit Kugellager	24	WS Nutfräser Planet mit Kugellager	41
HW Abrundfräser mit Kugellager	25	HW / WS Nutfräser Planet mit Kugellager horizontal	42
HW Viertelstabfräser mit Kugellager	26	HW / WS Stufenfräser	43
HW Fase- / Bündigfräser	27	WS Nutfräser TECTUS	43
HW Gratfräser	27	WS Beschlägefräser GLUTZ	44
HW Nut / Schriftenfräser	28	DP Fasfräser	45
HW Hohlkehlfräser	28	DP Bündigfräser	46
HW Dichtungsnutfräser	29	DP Abrundfräser	46
HW Planfräser	29	HW Kantennutfräser mit Aufnahmedorn ohne Kugellager T=12	46
HW Ausstech- / Bündigfräser mit Spitze	29	HW Kantennutfräser mit Aufnahmedorn und Kugellager	47
HW Wasserrinnenfräser	29	HW Kantennutfräser ohne Dorn Aufnahmedorn ohne Kugellager	49
HW Wasserrinnenfräser mit Kugellager	30	Aufnahmedorn mit Kugellager	50
HW Falzfräser Kugellager unten	30	Fräslehren	50
HW Kugelfräser	31		
HW T-Nutfräser	31		
HW Zinkenfräser mit Vorschneider 14°	31		
HW Handlauf-Fräser	32		

**20%**

**Aktionsrabatt**

Gültig bis 31. Okt.  
2017



## VHW Schruppfräser TURBEX ECOline

Art. Nr.	Qualität	D	SL	L	d1	Z	DR
TA680312	VHW	7,8	30	70	8	2	re.
TA680315	VHW	12	45	90	12	2	re.

## HW Nutfräser gerade

Art. Nr.	Qualität	D	SL	L	d1	Z	DR
TB680810	VHW	2	6	43	8	1	re.
TB680811	HW	3	8	46	8	1	re.
TB680812	HW	4	10	48	8	1	re.
TB680813	HW	5	12,7	50	8	1	re.
TB680814	HW	6	19	55	8	1	re.
TB680815	HW	3	8	59	12	1	re.
TB680816	HW	4	10	60	12	1	re.
TB680817	HW	5	12,7	62	12	1	re.
TB680818	HW	6	19	67	12	1	re.
TB680819	HW	8	20	67	12	1	re.
TB680820	HW	10	25	71	12	1	re.

## HW Nutfräser gerade ohne Zentrumschneide

Art. Nr.	Qualität	D	SL	L	d1	Z	DR
TB680821	HW	5	12	50	8	2	re.
TB680822	HW	5	16	53	8	2	re.
TB680823	HW	6	19	55	8	2	re.
TB680824	HW	6	25	61	8	2	re.
TB680825	HW	8	20	55	8	2	re.
TB680826	HW	8	30	65	8	2	re.
TB680827	HW	10	20	52	8	2	re.
TB680828	HW	10	30	62	8	2	re.



Art. Nr.	Qualität	D	SL	L	d1	Z	DR
TB680829	HW	12	20	52	8	2	re.
TB680830	HW	12	32	64	8	2	re.
TB680831	HW	12	38	70	8	2	re.
TB680832	HW	12	50	82	8	2	re.
TB680833	HW	14	20	52	8	2	re.
TB680834	HW	14	30	62	8	2	re.
TB680835	HW	15	20	52	8	2	re.
TB680836	HW	15	30	57	8	2	re.
TB680837	HW	16	20	52	8	2	re.
TB680838	HW	16	32	64	8	2	re.
TB680839	HW	16	38	70	8	2	re.
TB680840	HW	16	50	82	8	2	re.
TB680841	HW	18	20	52	8	2	re.
TB680842	HW	18	30	62	8	2	re.
TB680843	HW	20	20	52	8	2	re.
TB680844	HW	20	30	62	8	2	re.
TB680845	HW	22	20	52	8	2	re.
TB680846	HW	22	30	62	8	2	re.
TB680847	HW	24	20	52	8	2	re.
TB680848	HW	25	20	52	8	2	re.
TB680849	HW	25	30	62	8	2	re.

## HW Nutfräser gerade ohne Zentrumschneide

Art. Nr.	Qualität	D	SL	L	d1	Z	DR
TB680850	HW	5	12	61	12	2	re.
TB680851	HW	5	16	65	12	2	re.
TB680852	HW	6	19	67	12	2	re.
TB680853	HW	6	25	73	12	2	re.
TB680854	HW	8	20	67	12	2	re.
TB680855	HW	8	30	77	12	2	re.
TB680856	HW	10	20	66	12	2	re.
TB680857	HW	10	30	76	12	2	re.
TB680858	HW	12	20	64	12	2	re.
TB680859	HW	12	32	76	12	2	re.
TB680860	HW	12	38	82	12	2	re.
TB680861	HW	12	50	94	12	2	re.
TB680862	HW	14	20	62	12	2	re.
TB680863	HW	14	30	72	12	2	re.
TB680864	HW	15	20	60	12	2	re.

Art. Nr.	Qualität	D	SL	L	d1	Z	DR
TB680865	HW	16	20	60	12	2	re.
TB680866	HW	16	32	72	12	2	re.
TB680867	HW	16	38	78	12	2	re.
TB680868	HW	16	50	90	12	2	re.
TB680869	HW	18	20	60	12	2	re.
TB680870	HW	18	30	70	12	2	re.
TB680871	HW	20	20	60	12	2	re.
TB680872	HW	20	30	70	12	2	re.
TB680873	HW	22	20	60	12	2	re.
TB680874	HW	22	30	70	12	2	re.
TB680875	HW	24	20	60	12	2	re.
TB680876	HW	25	20	60	12	2	re.
TB680877	HW	25	30	70	12	2	re.

## HW Nutfräser gerade mit Zentrumschneide

Art. Nr.	Qualität	D	SL	L	d1	Z	DR
TB680878	VHW	3	8	45	8	2+1	re.
TB680879	VHW	4	12	50	8	2+1	re.
TB680880	VHW	5	20	65	8	2+1	re.
TB680881	VHW	6	20	69	8	2+1	re.
TB680882	VHW	7	20	66	8	2+1	re.
TB680883	HW	8	20	55	8	2+1	re.
TB680884	HW	8	30	90	8	2+1	re.
TB680885	HW	8	30	65	8	2+1	re.
TB680886	HW	9	20	55	8	2+1	re.
TB680887	HW	10	20	52	8	2+1	re.
TB680888	HW	10	30	62	8	2+1	re.
TB680889	HW	10	30	90	8	2+1	re.
TB680890	HW	11	20	52	8	2+1	re.
TB680891	HW	12	20	52	8	2+1	re.
TB680892	HW	12	30	62	8	2+1	re.
TB680893	HW	12	30	90	8	2+1	re.
TB680894	HW	12	38	70	8	2+1	re.
TB680895	HW	12	50	82	8	2+1	re.
TB680896	HW	12	63	92	8	2+1	re.
TB680897	HW	13	20	52	8	2+1	re.
TB680898	HW	14	20	52	8	2+1	re.
TB680899	HW	14	30	62	8	2+1	re.
TB680900	HW	14	30	90	8	2+1	re.
TB680901	HW	15	20	52	8	2+1	re.

Art. Nr.	Qualität	D	SL	L	d1	Z	DR
TB680902	HW	16	20	52	8	2+1	re.
TB680903	HW	16	20	70	8	2+1	re.
TB680904	HW	16	30	62	8	2+1	re.
TB680905	HW	16	30	90	8	2+1	re.
TB680906	HW	16	38	70	8	2+1	re.
TB680907	HW	16	50	82	8	2+1	re.
TB680908	HW	18	20	52	8	2+1	re.
TB680909	HW	18	20	70	8	2+1	re.
TB680910	HW	18	30	70	8	2+1	re.
TB680911	HW	20	20	52	8	2+1	re.
TB680912	HW	20	20	70	8	2+1	re.
TB680913	HW	20	32	64	8	2+1	re.
TB680914	HW	22	20	52	8	2+1	re.
TB680915	HW	22	20	70	8	2+1	re.
TB680916	HW	22	30	62	8	2+1	re.
TB680917	HW	24	20	52	8	2+1	re.
TB680918	HW	25	20	52	8	2+1	re.
TB680919	HW	28	20	52	8	2+1	re.
TB680920	HW	30	20	52	8	2+1	re.

## HW Nutfräser gerade mit Zentrumschneide

Art. Nr.	Qualität	D	SL	L	d1	Z	DR
TB680921	VHW	3	8	52	12	2+1	re.
TB680922	VHW	4	12	58	12	2+1	re.
TB680923	VHW	5	20	66	12	2+1	re.
TB680924	VHW	6	20	67	12	2+1	re.
TB680925	HW	8	20	67	12	2+1	re.
TB680926	HW	8	30	77	12	2+1	re.
TB680927	HW	10	20	66	12	2+1	re.
TB680928	HW	10	30	76	12	2+1	re.
TB680929	HW	10	35	90	12	2+1	re.
TB680930	HW	12	20	64	12	2+1	re.
TB680931	HW	12	30	74	12	2+1	re.
TB680932	HW	12	38	82	12	2+1	re.
TB680933	HW	12	50	94	12	2+1	re.
TB680934	HW	12	63	107	12	2+1	re.
TB680935	HW	14	20	62	12	2+1	re.
TB680936	HW	14	30	72	12	2+1	re.
TB680937	HW	14	35	90	12	2+1	re.
TB680938	HW	15	20	60	12	2+1	re.
TB680939	HW	15	35	90	12	2+1	re.



Art. Nr.	Qualität	D	SL	L	d1	Z	DR
TB680940	HW	16	20	60	12	2+1	re.
TB680941	HW	16	30	70	12	2+1	re.
TB680942	HW	16	38	78	12	2+1	re.
TB680943	HW	16	50	90	12	2+1	re.
TB680944	HW	16	60	110	12	2+1	re.
TB680945	HW	18	20	60	12	2+1	re.
TB680946	HW	18	35	90	12	2+1	re.
TB680947	HW	18	60	110	12	2+1	re.
TB680948	HW	20	20	60	12	2+1	re.
TB680949	HW	20	32	72	12	2+1	re.
TB680950	HW	20	35	90	12	2+1	re.
TB680951	HW	20	60	110	12	2+1	re.
TB680952	HW	22	20	60	12	2+1	re.
TB680953	HW	22	30	70	12	2+1	re.
TB680954	HW	22	35	90	12	2+1	re.
TB680955	HW	22	40	92	12	2+1	re.
TB680956	HW	22	60	110	12	2+1	re.
TB680957	HW	24	20	60	12	2+1	re.
TB680958	HW	24	35	90	12	2+1	re.
TB680959	HW	24	40	92	12	2+1	re.
TB680960	HW	25	20	60	12	2+1	re.
TB680961	HW	25	35	90	12	2+1	re.
TB680962	HW	26	42	94	12	2+1	re.
TB680963	HW	28	20	60	12	2+1	re.
TB680964	HW	28	42	94	12	2+1	re.
TB680965	HW	30	20	60	12	2+1	re.
TB680966	HW	30	35	90	12	2+1	re.
TB680967	HW	35	35	90	12	2+1	re.
TB680968	HS	12	20	50	8	2	re.
TB680969	HS	14	20	50	8	2	re.
TB680970	HS	15	20	50	8	2	re.
TB680971	HS	20	20	50	8	2	re.
TB680972	HS	22	25	57	8	2	re.
TB680973	HS	24	25	57	8	2	re.
TB680974	HS	25	25	57	8	2	re.
TB680800	HW	4	15	50	6,35	2	re.
TB680801	HW	6	14	50	6,35	2	re.
TB680802	HW	8	14	50	6,35	2	re.
TB680803	HW	8	32	63	6,35	2	re.
TB680804	HW	10	19	50	6,35	2	re.
TB680805	HW	12	20	50	6,35	2	re.
TB680806	HW	15	20	50	6,35	2	re.
TB680807	HW	16	19	50	6,35	2	re.
TB680808	HW	18	19	50	6,35	2	re.
TB680809	HW	20	19	50	6,35	2	re.

## HW Nutfräser Typ FESTOOL DOMINO

Art. Nr.	Qualität	D	SL	L	d1	Z
TB680558	HW	5	25	49	M6x0,75	2
TB680559	HW	6	25	49	M6x0,75	2
TB680560	HW	8	25	49	M6x0,75	2
TB680561	HW	10	25	49	M6x0,75	2

## HW Bündigfräser mit Kugellager am Schaft

Art. Nr.	Qualität	D	SL	L	d1	Z	DR
TB685002	HW	16	19	56	8	2	re.
TB685003	HW	16	25	62	8	2	re.
TB685004	HW	19	25	63	8	2	re.
TB685005	HW	22	25	64	8	2	re.

## Ersatzteile Kugellager

Art. Nr.	D	d	B
TB200608	16	8	5
TB200612	19	8	6
TA700425	22	8	7

## HW Bündigfräser mit Kugellager

Art. Nr.	Qualität	D	SL	L	d1	Z	DR
TB685006	HW	6,4	25,4	67	6,35	2	re.
TB685007	HW	9,5	12,7	55	8	2	re.
TB685008	HW	9,5	25,4	68	8	2	re.
TB685009	HW	12,7	12,7	55	8	2	re.
TB685010	HW	12,7	25,4	68	8	2	re.
TB685011	HW	19,05	19	62	8	2	re.
TB685012	HW	9,5	12,7	67	12	2	re.
TB685013	HW	9,5	25,4	80	12	2	re.
TB685015	HW	12,7	25,4	80	12	2	re.
TB685016	HW	12,7	38,1	93	12	2	re.
TB685017	HW	19,05	25,4	76	12	2	re.





## Ersatzteile Kugellager

Art. Nr.	D	d	B
TA700398	9,5	4,76	3,18
TA700395	12,7	4,76	4,76
TB200615	19,05	6,35	7,14

## HW Bündigfräser mit Achswinkel Kugellager unten

Art. Nr.	Qualität	D	SL	L	d1	Z	DR
TB685018	HW	12,7	25,4	65	8	2	re.
TB685019	HW	19,05	50,8	95	12	2	re.

## Ersatzteile Kugellager

Art. Nr.	D	d	B
TA700395	12,7	4,76	4,76
TB200614	19,05	12,7	5



## HW Fasfräser mit Kugellager

Art. Nr.	Grad	Qualität	D	SL	L	d1	Z	DR
TB685028	15°	HW	17,2	9,5	50	8	2	re.
TB685029	22,5°	HW	19,9	9,5	50	8	2	re.
TB685030	30°	HW	23	9,5	50	8	2	re.
TB685031	45°	HW	36	11,6	50	8	2	re.
TB685032	15°	HW	17,2	9,5	55	12	2	re.
TB685033	22,5°	HW	19,9	9,5	55	12	2	re.
TB685034	30°	HW	23	9,5	55	12	2	re.
TB685035	45°	HW	36	11,6	55	12	2	re.
TB685036	45°	HW	28,6	9	50	8	2	re.
TB685037	45°	HW	44,5	15,9	55	8	2	re.
TB685038	45°	HW	44,5	15,9	55	12	2	re.
TB685039	45°	HW	60,5	25	74	12	2	re.

## Ersatzteile Kugellager

Art. Nr.	D	d	B
TA700395	12,7	4,76	4,76
TA700398	9,5	4,76	3,18

## HW Abrundfräser mit Kugellager

Art. Nr.	R	Qualität	D	SL	L	d1	Z	DR
TB685040	R2	HW	16,7	9,5	50	8	2	re.
TB685041	R3	HW	18,7	9,5	50	8	2	re.
TB685042	R4	HW	20,7	9,5	50	8	2	re.
TB685043	R5	HW	22,7	9,5	50	8	2	re.
TB685044	R6	HW	24,7	12,7	50	8	2	re.
TB685045	R6,35	HW	25,4	12,7	50	8	2	re.
TB685046	R8	HW	28,6	12,7	50	8	2	re.
TB685047	R9,5	HW	31,8	15,9	55	8	2	re.
TB685048	R10	HW	32,7	16	55	8	2	re.
TB685049	R12	HW	36,7	19	60	8	2	re.
TB685050	R12,7	HW	38,1	19	60	8	2	re.
TB685051	R15	HW	43	22,3	60	8	2	re.
TB685052	R16	HW	44,7	22	60	8	2	re.

TB685168	R2	HW	16,7	9,5	55	12	2	re.
TB685169	R3	HW	18,7	9,5	55	12	2	re.
TB685170	R4	HW	20,7	9,5	55	12	2	re.
TB685171	R5	HW	22,7	9,5	55	12	2	re.
TB685172	R6	HW	24,7	12,7	60	12	2	re.
TB685173	R6,35	HW	25,4	12,7	60	12	2	re.
TB685174	R8	HW	28,6	12,7	60	12	2	re.
TB685175	R9,5	HW	31,8	15,9	65	12	2	re.
TB685176	R10	HW	32,7	16	65	12	2	re.
TB685177	R12	HW	36,7	19	65	12	2	re.
TB685178	R12,7	HW	38,1	19	65	12	2	re.
TB685179	R16	HW	44,7	22,2	70	12	2	re.
TB685180	R19	HW	50,8	25,4	70	12	2	re.
TB685181	R22,2	HW	57,1	28,6	75	12	2	re.
TB685182	R25,4	HW	63,5	31,8	85	12	2	re.
TB685183	R28,6	HW	69,9	34,9	85	12	2	re.
TB685184	R31,8	HW	76,2	38,1	90	12	2	re.







## Ersatzteile Kugellager

Art. Nr.	D	d	B
TA700395	12,7	4,76	4,76

## HW Viertelstabfräser mit Kugellager

Art. Nr.	R	Qualität	D	SL	L	d1	Z	DR
TB685053	R2	HW	16,7	9,5	55	8	2	re.
TB685054	R3	HW	18,7	9,5	55	8	2	re.
TB685055	R4	HW	20,7	9,5	55	8	2	re.
TB685056	R5	HW	22,7	9,5	55	8	2	re.
TB685057	R6	HW	24,7	12,7	60	8	2	re.
TB685058	R6,35	HW	25,4	12,7	60	8	2	re.
TB685059	R8	HW	28,7	12,7	60	8	2	re.
TB685060	R9,5	HW	31,8	15,9	65	8	2	re.
TB685061	R10	HW	32,7	16	65	8	2	re.
TB685062	R12	HW	36,7	19	65	8	2	re.
TB685063	R12,7	HW	38,1	19	65	8	2	re.
TB685064	R16	HW	44,7	22,2	70	8	2	re.
TB685151	R2	HW	16,7	9,5	55	12	2	re.
TB685152	R3	HW	18,7	9,5	55	12	2	re.
TB685153	R4	HW	20,7	9,5	55	12	2	re.
TB685154	R5	HW	22,7	9,5	55	12	2	re.
TB685155	R6	HW	24,7	12,7	60	12	2	re.
TB685156	R6,35	HW	25,4	12,7	60	12	2	re.
TB685157	R8	HW	28,7	12,7	60	12	2	re.
TB685158	R9,5	HW	31,8	15,9	65	12	2	re.
TB685159	R10	HW	32,7	16	65	12	2	re.
TB685160	R12	HW	36,7	19	65	12	2	re.
TB685161	R12,7	HW	38,1	19	65	12	2	re.
TB685162	R16	HW	44,7	22,2	70	12	2	re.
TB685163	R19,05	HW	50,8	25,4	70	12	2	re.
TB685164	R22,2	HW	57,2	28,6	75	12	2	re.
TB685165	R25,4	HW	63,5	31,8	85	12	2	re.
TB685166	R28,6	HW	69,9	34,9	85	12	2	re.
TB685167	R31,75	HW	76,2	38,1	90	12	2	re.

## Ersatzteile Kugellager

Art. Nr.	D	d	B
TA700398	9,5	4,76	3,18

## HW Fase-/ Bündigfräser

Art. Nr.	Grad	Qualität	D	SL	L	d1	Z	DR
TB680594	30°	HW	12,7	12,7	45	6,35	2	re.
TB680595	22°	HW	12,7	12,7	45	8	2	re.
TB680596	30°	HW	12,7	12,7	45	8	2	re.
TB680597	45°	HW	12,7	12,7	45	8	2	re.

## HW Gratfräser

Art. Nr.	Grad	Qualität	D	SL	L	d1	Z	DR
TB680581	7.5°	HW	6,35	7,9	45	8	2	re.
TB680582	9°	HW	9,5	9,5	47	8	2	re.
TB680583	12°	HW	9,5	9,5	47	8	2	re.
TB680584	14°	HW	12,7	12,7	49	8	2	re.
TB680585	14°	HW	14,3	12,7	49	8	2	re.
TB680586	15°	HW	14,3	13,5	49	8	2	re.
TB680587	15°	HW	22	22	60	8	2	re.

TB680588	7°	HW	19	22,2	69	12	2	re.
TB680589	9°	HW	9,5	9,5	55	12	2	re.
TB680590	14°	HW	12,7	12,7	59	12	2	re.
TB680591	14°	HW	14,3	12,7	59	12	2	re.
TB680592	14°	HW	19	19	65	12	2	re.
TB680593	14°	HW	25,4	22,2	69	12	2	re.





## HW Nut / Schriftenfräser

Art. Nr.	Grad	Qualität	D	SL	L	d1	Z	DR
TB680630	60°	HW	12,7	15,9	48	8	2	re.
TB680631	60°	HW	19,05	20,6	53	8	2	re.
TB680632	90°	HW	6,35	9,5	42	8	2	re.
TB680633	90°	HW	9,5	12,7	45	8	2	re.
TB680634	90°	HW	12,7	12,7	45	8	2	re.
TB680635	90°	HW	15,9	12,7	45	8	2	re.
TB680636	90°	HW	19,05	15,9	48	8	2	re.
TB680637	90°	HW	32	22	54	8	2	re.
TB680638	60°	HW	15,1	13,1	48	8	3	re.
TB680639	60°	HW	19,05	20,6	61	12	2	re.
TB680640	90°	HW	6,35	9,5	50	12	2	re.
TB680641	90°	HW	9,5	12,7	53	12	2	re.
TB680642	90°	HW	12,7	12,7	53	12	2	re.
TB680643	90°	HW	15,9	12,7	53	12	2	re.
TB680644	90°	HW	19,05	15,9	56	12	2	re.
TB680645	90°	HW	32	23,5	64	12	2	re.



## HW Hohlkehlfraäser

Art. Nr.	R	Qualität	D	SL	L	d1	Z	DR
TB680610	R3	HW	6	6	38	8	2	re.
TB680611	R5	HW	10	9,5	42	8	2	re.
TB680612	R6	HW	12	9,5	42	8	2	re.
TB680613	R6,35	HW	12,7	9,5	42	8	2	re.
TB680614	R8	HW	16	12	44	8	2	re.
TB680615	R9,5	HW	19	11	43	8	2	re.
TB680616	R10	HW	20	16	48	8	2	re.
TB680617	R12,7	HW	25,4	19	51	8	2	re.
TB680618	R3	HW	6	6	46	12	2	re.
TB680619	R4	HW	8	8	48	12	2	re.
TB680620	R5	HW	10	9,5	50	12	2	re.
TB680621	R6	HW	12	9,5	50	12	2	re.
TB680622	R6,35	HW	12,7	25,4	66	12	2	re.
TB680623	R8	HW	16	12	52	12	2	re.
TB680624	R9,5	HW	19	11	51	12	2	re.
TB680625	R10	HW	20	16	56	12	2	re.
TB680626	R12,7	HW	25,4	19	59	12	2	re.
TB680627	R19,05	HW	38,1	22,2	63	12	2	re.
TB680628	R25,4	HW	50,8	31,8	72	12	2	re.

## HW Dichtungsnutfräser

Art. Nr.	Qualität	D	SL	L	d1	Z	DR
TB680629	HW	3	8	55	6,35	2	re.

## HW Planfräser

Art. Nr.	Qualität	D	SL	L	d1	Z	DR
TB680606	HW	19	12	44	8	2	re.
TB680607	HW	30	12	44	8	2	re.
TB680608	HW	19	12	52	12	2	re.
TB680609	HW	30	12	52	12	2	re.
TA702418	HW	52	7		12	6	re.

## HW Ausstech-/ Bündigfräser mit Spitze

Art. Nr.	Qualität	D	SL	L	d1	Z	DR
TB680603	HW	8	19	64	8	1+1	re.
TB680604	HW	8	25,4	73	8	1+1	re.
TB680605	HW	12	25,4	84	12	1+1	re.

## HW Wasserrinnenfräser

Art. Nr.	R	Qualität	D	SL	L	d1	Z	DR
TB680564	R3	HW	6	12,7	45	8	1	re.
TB680565	R4,76	HW	9,5	12,7	45	8	2	re.
TB680566	R6,35	HW	12,7	15,9	48	8	2	re.
TB680567	R4,76	HW	9,5	12,7	53	12	2	re.
TB680568	R6,35	HW	12,7	15,9	56	12	2	re.
TB680569	R12,7	HW	25,4	31,8	72	12	2	re.







## HW Wasserrinnenfräser mit Kugellager

Art. Nr.	R	Qualität	D	SL	L	d1	Z	DR
TB685000	R6	HW	12	16	55	8	2	re.
TB685001	R12,7	HW	25,4	31,8	80	12	2	re.

## Ersatzteile Kugellager

Art. Nr.	R	D	d	B
TB200600	R6	12	8	3,5
TB200619	R12,7	25,4	12,7	5



## HW Falzfräser Kugellager unten

Art. Nr.	T	Qualität	D	SL	L	d1	Z	DR
TB685067	T=9,5	HW	31,8	12,7	49	8	2	re.
TB685068	T=9,5	HW	31,8	12,7	54	12	2	re.

## Ersatzteile

Art. Nr.	D	d	B
TA700395	12,7	4,76	4,76

## HW Kugelfräser

Art. Nr.	R	Qualität	D	SL	L	d1	Z	DR
TB680570	R4,75	HW	9,5	8,3	41	8	2	re.
TB680571	R6,35	HW	12,7	11,6	44	8	2	re.
TB680572	R8	HW	15,9	14,8	47	8	2	re.
TB680573	R9,5	HW	19,05	18,2	51	8	2	re.
TB680574	R4,75	HW	9,5	8,3	50	12	2	re.
TB680575	R6,35	HW	12,7	11,6	55	12	2	re.
TB680576	R8	HW	15,9	14,4	60	12	2	re.
TB680577	R9,5	HW	19,05	17,6	64	12	2	re.

## HW T-Nutfräser

Art. Nr.	Qualität	D	SL	L	d1	Z	DR
TB680562	HW	9,5/4,8	4,8	45	8	1	re.
TB680563	HW	12,7/6,35	4,8	45	8	2	re.

## HW Zinkenfräser mit Vorschneider 14°

Art. Nr.	Grad	Qualität	D	SL	L	d1	Z	DR
TB680579	14°	HW	14,3/12,7	13,5	46	8	2	re.
TB680580	14°	HW	14,3/12,7	13,5	46	12	2	re.



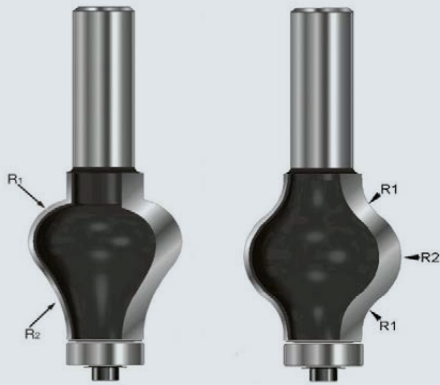

Profil 1

Profil 2



## HW Handlauf-Fräser

Art. Nr.	Profil	Qualität	D	SL	L	d1	Z	DR
TB685065	1	HW	31,8	38,1	85	12	2	re.
TB685066	2	HW	31,8	38,1	85	12	2	re.

## Ersatzteile Kugellager

Art. Nr.	D	d	B
TA700396	15,9	6,35	4,76

## HW Griffmuldenfräser

Art. Nr.	Profil	Qualität	D	SL	L	d1	Z	DR
TB680578	R4,75/2,4	HW	19	17,5	50	8	2	re.

## WS Nutfräser gerade

Art. Nr.	Profil	Qualität	D	SL	L	d1	Z	DR
TB685088		HW-WS	14	19,5	65	8	2	re.
TB685089	VS 57	HW-WS	14,6	19,5	65	8	2	re.
TB685090		HW-WS	15	19,5	65	8	2	re.
TB685091		HW-WS	16	19,5	65	8	2	re.
TB685092		HW-WS	18	19,5	65	8	2	re.
TB685093	Schloss-Stulp	HW-WS	18,1	19,5	65	8	2	re.
TB685094		HW-WS	20	19,5	65	8	2	re.
TB685095	Schloss-Stulp	HW-WS	20,1	19,5	65	8	2	re.
TB685096		HW-WS	24	19,5	65	8	2	re.
TB685097		HW-WS	25	19,5	65	8	2	re.
TB685098		HW-WS	14	29,5	75	8	2	re.
TB685099		HW-WS	15	29,5	75	8	2	re.
TB685100		HW-WS	16	29,5	75	8	2	re.

Art. Nr.	Profil	Qualität	D	SL	L	d1	Z	DR
TB685101		HW-WS	18	29,5	75	8	2	re.
TB685102	Schloss-Stulp	HW-WS	18,1	29,5	75	8	2	re.
TB685103		HW-WS	20	29,5	75	8	2	re.
TB685104	Schloss-Stulp	HW-WS	20,1	29,5	75	8	2	re.
TB685105		HW-WS	14	29,5	80	12	2	re.
TB685106		HW-WS	15	29,5	80	12	2	re.
TB685107		HW-WS	16	29,5	80	12	2	re.
TB685108		HW-WS	18	29,5	80	12	2	re.
TB685109	Schloss-Stulp	HW-WS	18,1	29,5	80	12	2	re.
TB685110		HW-WS	20	29,5	80	12	2	re.
TB685111	Schloss-Stulp	HW-WS	20,1	29,5	80	12	2	re.
TB685112		HW-WS	24	29,5	80	12	2	re.
TB685113		HW-WS	25	29,5	80	12	2	re.
TB685114		HW-WS	14	49,5	103	12	2	re.
TB685115		HW-WS	15	49,5	103	12	2	re.
TB685116		HW-WS	16	49,5	103	12	2	re.
TB685117		HW-WS	18	49,5	103	12	2	re.
TB685118		HW-WS	20	49,5	103	12	2	re.
TB685119		HW-WS	24	49,5	103	12	2	re.
TB685120		HW-WS	25	49,5	103	12	2	re.

## Ersatzteile Wendeschneiden mit Spanleitstufe

Art. Nr.	D	Qualität	B	h	a
TB219077	D14	HW	19,5	7	1,5
TB219078	D14,6	HW	19,5	7,3	1,5
TB219079	D15/16	HW	19,5	7,5	1,5
TB219080	D18/18,1	HW	19,5	9	1,5
TB219081	D20/20,1	HW	19,5	10	1,5
TB219082	D24/25	HW	19,5	12	1,5
TB219083	D14	HW	29,5	7	1,5
TB219084	D15/16	HW	29,5	7,5	1,5
TB219085	D18/18,1	HW	29,5	9	1,5
TB219086	D20/20,1	HW	29,5	10	1,5
TB219087	D24/25	HW	29,5	12	1,5





## Ersatzteile Wendeschneiden

Art. Nr.	D	Qualität	B	h	a
TB219076	Brustnut D14/15	HW	50	5,5	1,1
TB219068	4-seitig zu D16	HW	49,5	8	1,5
TB219069	4-seitig zu D18	HW	49,5	9	1,5
TB219070	4-seitig zu D20	HW	49,5	10	1,5
TB219071	4-seitig zu D24/25	HW	49,5	12	1,5

## Ersatzteile

Art. Nr.		M	L	Typ
TB200702	Spannschrauben	3	4	Torx 9
TB200704	Spannschrauben	3,5	4,8	Torx 15
TA851107	Gewindestift	3,5	5,5	Torx 15
TB200706	Gewindestift	3	4	Torx 6

## WS Bündigfräser mit Kugellager unten

Art. Nr.	Qualität	D	SL	L	d1	Z	DR
TB685140	HW-WS	12,7	8,5	57	8	2	re.
TB685141	HW-WS	12,7	20	70	8	2	re.
TB685142	HW-WS	15,9	12	57	8	2	re.
TB685143	HW-WS	19	20	61	8	2	re.
TB685144	HW-WS	19	30	71	8	2	re.
TB685145	HW-WS	19	30	71	12	2	re.
TB685146	HW-WS	19	40	90	12	2	re.
TB685147	HW-WS	19	50	100	12	2	re.

## Ersatzteile Wendeschneiden

Art. Nr.	D	Qualität	B	h	a
TB219073	D12,7x8,5	HW	8,5	5,5	1,1
TB219088	D12,7x20	HW	20	5,5	1,1

Art. Nr.	D	Qualität	B	h	a
TA219742	D15.9	HW	12	12	1.5
TA219710	D19x20	HW	20	12	1.5
TA219713	D19x30	HW	30	12	1.5
TA219714	D19x40	HW	40	12	1.5
TA219715	D19x50	HW	50	12	1.5

## Ersatzteile Kugellager

Art. Nr.	D	d
TA700395	12,7	4,76
TA700396	15,9	6,35
TB200612	19	8

## Ersatzteile

Art. Nr.		M	L	Typ
TB200706	Gewindestift zu D12,7	3	4	Torx 6
TB200703	Spannschraube zu D15,9/19	3,5	4,4	Torx 15
TB200700	Linsenkopfschraube zu Kugellager	4	6	ISK
TA851062	Linsenkopfschraube zu Kugellager	5	6	Torx 20

## WS Bündigfräser mit Kugellager am Schaft

Art. Nr.	Qualität	D	SL	d1	Z	DR
TB685148	HW-WS	19	19,5	8	2	re.
TB685149	HW-WS	19	29,5	8	2	re.
TB685150	HW-WS	19	29,5	12	2	re.





## Ersatzteile Wendeschneide 4-seitig

Art. Nr.	Qualität	B	h	a
TB219072	HW	19,5	12	1,5
TA217769	HW	29,5	12	1,5

## Ersatzteile Kugellager

Art. Nr.	D	d
TB200612	19	8
TB200613	19	10

## Ersatzteile Spanschraube Schneide

Art. Nr.	M	L	Typ
TB200613	3,5	4,4	Torx 15

## WS Fasfräser mit Kugellager

Art. Nr.	Grad	Qualität	D	SL	L	d1	Z	DR
TB685131	22°	HW-WS	24	12	60	8	2	re.
TB685132	30°	HW-WS	25,5	12	60	8	2	re.
TB685133	45°	HW-WS	32	12	60	8	2	re.
TB685134	30°	HW-WS	36	20	78	12	2	re.
TB685135	45°	HW-WS	57	30	86	12	2	re.

## Ersatzteile Wendeschneiden

Art. Nr.	Qualität	B	h	a	
TA219742	Wendeschneide zu 22°/30°/45°	HW	12	12	1,5
TA219710	Wendeschneide zu 30°/d1=12	HW	20	12	1,5
TA219713	Wendeschneide zu 45°/d1=12	HW	30	12	1,5

## Ersatzteile Kugellager

Art. Nr.	D	d
TB200607	16	6
TB200601	12,7	6,35
TA700396	15,9	6,35

## Ersatzteile

Art. Nr.		M	L	Typ
TB200705	Spannschraube zu WS+Kugellager Schaft 8	4	4	Torx 15
TB200703	Spannschraube zu WS Schaft 12	3,5	4,4	Torx 15
TA851062	Linsenkopfschraube zu Kugellager	5	6	Torx 20

## WS Abrundfräser, Körper ohne WS und Kugellager

Art. Nr.	D	SL	L	d1	Z	DR
TB685123	19	12	63	8	2	re.

## Ersatzteile Wendeschneiden

Art. Nr.	R	Qualität	B	h	a
TB219056	R1	HW	12	12	1,5
TB219057	R1,5	HW	12	12	1,5
TB219058	R2	HW	12	12	1,5
TB219059	R2,5	HW	12	12	1,5
TB219060	R3	HW	12	12	1,5







## Ersatzteile Kugellager

Art. Nr.	R	D	d
TB200610	R1	17	5
TB200606	R1,5	16	5
TB200604	R2	15	5
TB200603	R2,5	14	5
TB200602	R3	13	5

## Ersatzteile Spannschraube WS + Kugellager

Art. Nr.	M	L	Typ
TB200703	3,5	4,4	Torx 15

## WS Abrund-/ Viertelstabfräser (Lieferung inkl. 2 Kugellager)

Art. Nr.	R	Qualität	D	SL	L	d1	Z	DR
TB685124	R2	HW-WS	19,7	19	62	8	2	re.
TB685125	R3	HW-WS	21,7	19	68	8	2	re.
TB685126	R4	HW-WS	23,7	19,5	68	8	2	re.
TB685127	R5	HW-WS	25,7	19,5	73	8	2	re.
TB685128	R6	HW-WS	28,7	23	73	8	2	re.
TB685129	R8	HW-WS	34,7	23	73	8	2	re.
TB685130	R10	HW-WS	33	30	73	8	2	re.

## Ersatzteile Wendeschneiden

Art. Nr.	R	Qualität	B	h	a
TB219061	R2	HW	19	7	1,5
TB219062	R3	HW	19	7	1,5
TB219063	R4	HW	19,5	8	1,5
TB219064	R5	HW	19,5	9	1,5
TB219065	R6	HW	23	10	1,5
TB219066	R8	HW	23	12	1,5
TB219067	R10	HW	30	12	1,5

## Ersatzteile Kugellager

Art. Nr.	KL	D	d
TB200605	Abrund	15,7	4,75
TA700395	Viertelstab	12,7	4,76
TB200609	Abrund	16,7	4,75
TB200611		18,7	4,75
TB200602		13	5

## Ersatzteile

Art. Nr.	R	M	L	Typ
TB200702	Spannschraube zu R2/R3	3	4	Torx 9
TB200704	Spannschraube R4/R5	3,5	4,8	Torx 15
TA851107	Gewindestift zu R6-R10	3,5	5	Torx 15
TB200701	Linienkopfschraube Kugellager	4	12	ISK

## WS Bündig-/ Fasfräser

Art. Nr.	Grad	Qualität	D	SL	L	d1	Z	DR
TB685136	22°	HW-WS	16	5	44	8	2	re.
TB685137	30°	HW-WS	16	5	49	8	2	re.
TB685138	45°	HW-WS	16	5	49	8	2	re.

## Ersatzteile Wendeschneiden

Art. Nr.	Grad	Qualität	B	h
TB219053	22°	HW	12	7
TB219054	30°	HW	12	7
TB219055	45°	HW	12	7





## Ersatzteile Spannschraube

Art. Nr.	M	L	Typ
TB200702	3	4	Torx 9

## WS Falzfräser mit Kugellager

Art. Nr.	Qualität	D	SL	L	d1	Z	DR
TB685139	HW-WS	32	19,5	61	8	2	re.

## Ersatzteile Wendeschneiden 4-seitig

Art. Nr.	Qualität	B	h	a
TB219072	HW	19,5	12	1,5

## Ersatzteile Kugellager

Art. Nr.		D	d
TB200617	Kugellager für T=4	24	6,35
TB200616	Kugellager für T=6	20	6,35
TA700396	Kugellager für T=8	15,9	6,35
TB200601	Kugellager für T=9,65	12,7	6,35

## Ersatzteile

Art. Nr.		M	L	Typ
TA851107	Gewindestift Wendeschneiden	3,5	5	Torx 15
TA851062	Linienkopfschraube Kugellager	5	6,3	Torx 20

## HW / WS Nutfräser Planet ohne Kugellager

Art. Nr.	Qualität	D	SL	L	d1	Z	DR
TB685084	VHW	8,1	35	80	8	2	re.
TB685085	HW	13,1	30	80	8	2	re.
TB685086	HW	13,1	40	80	8	2	re.
TB685087	HW-WS	13,1	40	80	8	2	re.

## Ersatzteile Wendeschneide mit Brustnut

Art. Nr.	Qualität	B	h	a
TB219075	HW	40	5,5	1,1

## Ersatzteile Gewindestift

Art. Nr.	M	L	Typ
TB200706	3	4	Torx 6

## WS Nutfräser Planet mit Kugellager

Art. Nr.	Qualität	D	SL	L	d1	Z	DR
TA700550	HW-WS	12,7	15	85	8	2	re

## Ersatzteile Wendeschneide

Art. Nr.	Qualität	B	h	a
TA217816	HW	15	5,5	1,1





## HW / WS Nutfräser Planet mit Kugellager horizontal

Art. Nr.	Qualität	D	SL	d1	Z	DR
<b>TB685081</b>	HW	86	8,1	12	4 WZ	re.
<b>TB685082</b>	HW-WS	86	8,1	12	4+4	re.
<b>TB685083</b>	HW-WS	92	13	12	4+4	re.

## Ersatzteile Wendeschneide

Art. Nr.		Qualität	B	h	a
<b>TA219742</b>	Wendeschneide zu B=13	HW	12	12	1,5
<b>TA217765</b>	Vorschneider zu B=8,1/13	HW	14	14	2
<b>TA219700</b>	Wendeschneide zu B=8,1	HW	7,5	12	1,5

## Ersatzteile Kugellager

Art. Nr.		D	d
<b>TB200618</b>	B=13	24	12
<b>TB200608</b>	B/8,1	16	8

## Ersatzteile

Art. Nr.		M	L	Typ
<b>TA851038</b>	Senkkopfschr. zu Vorschneider B8.1/13	5	6,3	Torx 15
<b>TA851549</b>	Gewindestift zu Räumler B13	6	12	Torx 15
<b>TB200707</b>	Gewindestift mit Zapfen zu Räumler 8,1	5	12	ISK
<b>TB200542</b>	Anlauf-Mutter B13	10		
<b>TB200543</b>	Anlauf-Mutter B8,1	8		

## HW / WS Stufenfräser

Art. Nr.		Qualität	D	SL	L	d1	Z	DR
TB685073	Euronut	HW	12,3/16,3	9,5	65	8	2	re.
TB685074	Euronut	HW-WS	12,3/16,3	9,5	70	8	2	re.
TB685075	Stulp 18 mm	HW	13,3/18,3	5,5	60	8	2	re.
TB685076	Stulp 18 mm	HW-WS	13,3/18,3	6,5	70	8	2	re.
TB685077	Stulp 18 mm	HW-WS	13,3/18,3	6,5	75	12	2	re.
TB685078	Stulp 20 mm	HW	13,3/20,3	5,5	60	8	2	re.
TB685079	Stulp 20 mm	HW-WS	13,3/20,3	6,5	70	8	2	re.
TB685080	Stulp 20 mm	HW-WS	13,3/20,3	6,5	75	12	2	re.

## Ersatzteile Wendeschneiden

Art. Nr.		Qualität	B	h
TB219050	zu Euronut 12,3/16,3	HW	12,3	9,3/16,3
TB219051	zu Stulp 18, 13,3/18,3	HW	13,3	6,5/18,3
TB219052	zu Stulp 20, 13,3/20,3	HW	13,3	6,5/20,3

## Ersatzteile Spannschraube

Art. Nr.		M	L	Typ
TB200703	Spannschraube zu Euronut	3,5	4,4	Torx 15
TB200704	Spannschraube zu Stulp 18/20	3,5	4,8	Torx 15

## WS Nutfräser TECTUS

Art. Nr.	Qualität	D	SL	L	d1	Z	DR
TB685121	HW-WS	16	30	120	12	2	re.
TB685122	HW-WS	24	29,5	120	12	2	re.







Typ 1160



Typ 1150

## Ersatzteile Wendeschneiden

Art. Nr.		Qualität	B	h	a
TB219074	mit Brustnut zu D 16	HW	30	5,5	1,1
TB219085	mit Spanleitstufe zu D24	HW	29,5	9	1,5

## Ersatzteile Spannschraube

Art. Nr.		M	L	Typ
TB200706	Gewindestift zu D16	3	4	Torx 6
TB200704	Spannschraube zu D24	3,5	4,8	Torx 15

## WS Beschlügefräser GLUTZ

Art. Nr.		Qualität	D	SL	d1	Z	DR
TA700413	1150/51/53	HW-WS	46	2,8	8	2	re.
TA700414	1150/51/53	HW-WS	46	2,8	12	2	re.
TA700417	1160	HW-WS	30	23	8	2	re.
TA700418	1160	HW-WS	30	23	12	2	re.

## Ersatzteile Wendeschneiden

Art. Nr.		Qualität	B	h	a
TA217802	Glutz 1160	HW	23	10	1,5
TA217803	Glutz 1150/51/53	HW	19,3	7,7	1,5

## Ersatzteile Nutsäge

Art. Nr.	Qualität	D	B
TA217806	HW	46	2,8

## Ersatzteile Kugellager

Art. Nr.	D	d
TA700425	22	8

## Ersatzteile Gewindestift / Schrauben

Art. Nr.		M	L	Typ
TA851106	Glutz 1150	3	5	ISK 2,5
TA851107	Glutz 1160	3,5	5	Torx 15
TA851190	Nutsäge	6	16	ISK 5
TA851191	Glutz 1160	5	16	ISK 4

## DP Fasfräser

Art. Nr.	Grad	Qualität	D	SL	d1	Z	DR
TA700509	22°	DP	22	6	8	2	re.
TA700510	30°	DP	24	7	8	2	re.
TB685069	45°	DP	22,8	5,1	8	2	re.

## Ersatzteile Kugellager

Art. Nr.	Grad	D	d
TA700396	22°/30°	15,9	6,35
TA700395	45°	12,7	4,76





## DP Bündigfräser

Art. Nr.	Qualität	D	SL	d1	Z	DR
TB685070	DP	12,7	10	8	2	re.
TA700508	DP	19	6	8	2	re.

## Ersatzteile Kugellager

Art. Nr.		D	d
TA700395	Kugellager zu D12,7	12,7	4,76
TA700396	Kugellager zu D19	15,9	6,35
TA700401	Aufsteckring zu D19	19	16

## DP Abrundfräser

Art. Nr.	Qualität	D	SL	d1	Z	DR
TB685071	R3 DP	20	4,2	8	2	re.
TB685072	R5 DP	23	6,1	8	2	re.

## Ersatzteile Kugellager

Art. Nr.	D	d
TA700395	12,7	4,76

## HW Kantennutfräser mit Aufnahmedorn ohne Kugellager T=12

Art. Nr.	Qualität	D	SL	L	d1	Z	DR
TB681003	HW	40	2	50	8	2	re.
TB681004	HW	40	3	50	8	2	re.
TB681005	HW	40	4	50	8	2	re.
TB681006	HW	40	5	50	8	2	re.
TB681007	HW	40	6	50	8	2	re.

## Ersatzteile Kantennutfräser mit Ansenkung

Art. Nr.	Qualität	D	SL	d1	Z	DR
TB680996	HW	40	2	8	2	re.
TB680997	HW	40	3	8	2	re.
TB680998	HW	40	4	8	2	re.
TB680999	HW	40	5	8	2	re.
TB681000	HW	40	6	8	2	re.

## Ersatzteile Aufnahmedorn

Art. Nr.	d1
TB675004	8

## Ersatzteile Senkkopfschraube

Art. Nr.	M	L	Typ
TA851190	6	16	ISK 5

## HW Kantennutfräser mit Aufnahmedorn und Kugellager

Art. Nr.	Qualität	D	SL	L	d1	Z	DR
TB685020	T=10,5 HW	40	2	54	8	2	re.
TB685021	T=6 HW	40	2,5	55	8	2	re.
TB685022	T=4 HW	40	2,5	55	8	2	re.
TB685023	T=6 HW	40	2,8	55	8	2	re.
TB685024	T=4 HW	40	2,8	55	8	2	re.
TB685025	T=10,5 HW	40	3	54	8	2	re.
TB685026	T=10,5 HW	40	4	54	8	2	re.
TB685027	T=10,5 HW	40	5	54	8	2	re.



## Ersatzteile Kantennutfräser mit Ansenkung

Art. Nr.	Qualität	D	SL	Z	DR
TB680996	HW	40	2	2	re.
TB681001	HW	40	2,5	2	re.
TB681002	HW	40	2,8	2	re.
TB680997	HW	40	3	2	re.
TB680998	HW	40	4	2	re.
TB680999	HW	40	5	2	re.

## Ersatzteile Aufnahmedorn

Art. Nr.	d1
TB675005	8

## Ersatzteile Kugellager

Art. Nr.	D	d	B
TB200614	19,05	12,7	5
TB200620	28	12,7	5
TB200621	32	12,7	5

## Ersatzteile Senkkopfschraube

Art. Nr.	M	L	Typ
TA851190	6	16	ISK 5

## HW Kantennutfräser ohne Dorn

Art. Nr.	Qualität	D	SL	d1	Z
TB680975	HW	40	2	6,35	2
TB680976	HW	40	2,5	6,35	2
TB680977	HW	40	3	6,35	2
TB680978	HW	40	3,5	6,35	2
TB680979	HW	40	4	6,35	2
TB680980	HW	40	5	6,35	2
TB680981	HW	40	6	6,35	2
TB680982	HW	47,6	3	8	2
TB680983	HW	47,6	4	8	2
TB680984	HW	47,6	2	8	3
TB680985	HW	47,6	2,5	8	3
TB680986	HW	47,6	3	8	3
TB680987	HW	47,6	4	8	3
TB680988	HW	47,6	5	8	3
TB680989	HW	47,6	6	8	3
TB680990	HW	50,8	2	8	4
TB680991	HW	50,8	2,5	8	4
TB680992	HW	50,8	3	8	4
TB680993	HW	50,8	4	8	4
TB680994	HW	50,8	5	8	4
TB680995	HW	50,8	6	8	4

## Aufnahmedorn ohne Kugellager

Art. Nr.	D	L	d1
TB675006	6,35	68,5	8
TB675007	6,35	76	12
TB675008	8	68,5	8
TB675009	8	76	12







## Aufnahmedorn mit Kugellager

Art. Nr.	D	D	L	d1
TB675000	D=19	6,35	68,5	8
TB675001	D=19	6,35	76	12
TB675002	D=22	8	68,5	8
TB675003	D=22	8	76	12

## Ersatzteile Kugellager

Art. Nr.	D	d	B
TB200615	19,05	6,35	7,14
TA700425	22	8	

## Fräslehren

Art. Nr.		
TB200199	Fräslehre komplett zu Glutz 1150/51	<b>A</b>
TB200195	Ausreisschutz zu allen Fräslehren 1150 + 3-Punkt	<b>C</b>
TB200197	Fräslehre komplett zu 3-Punkt Treplane 1835/1834	<b>A / F / E</b>
TB200198	Fräslehre komplett zu Glutz 1160	<b>B / A</b>
TB200196	Ausreisschutz zu Fräslehre 1160	<b>D</b>

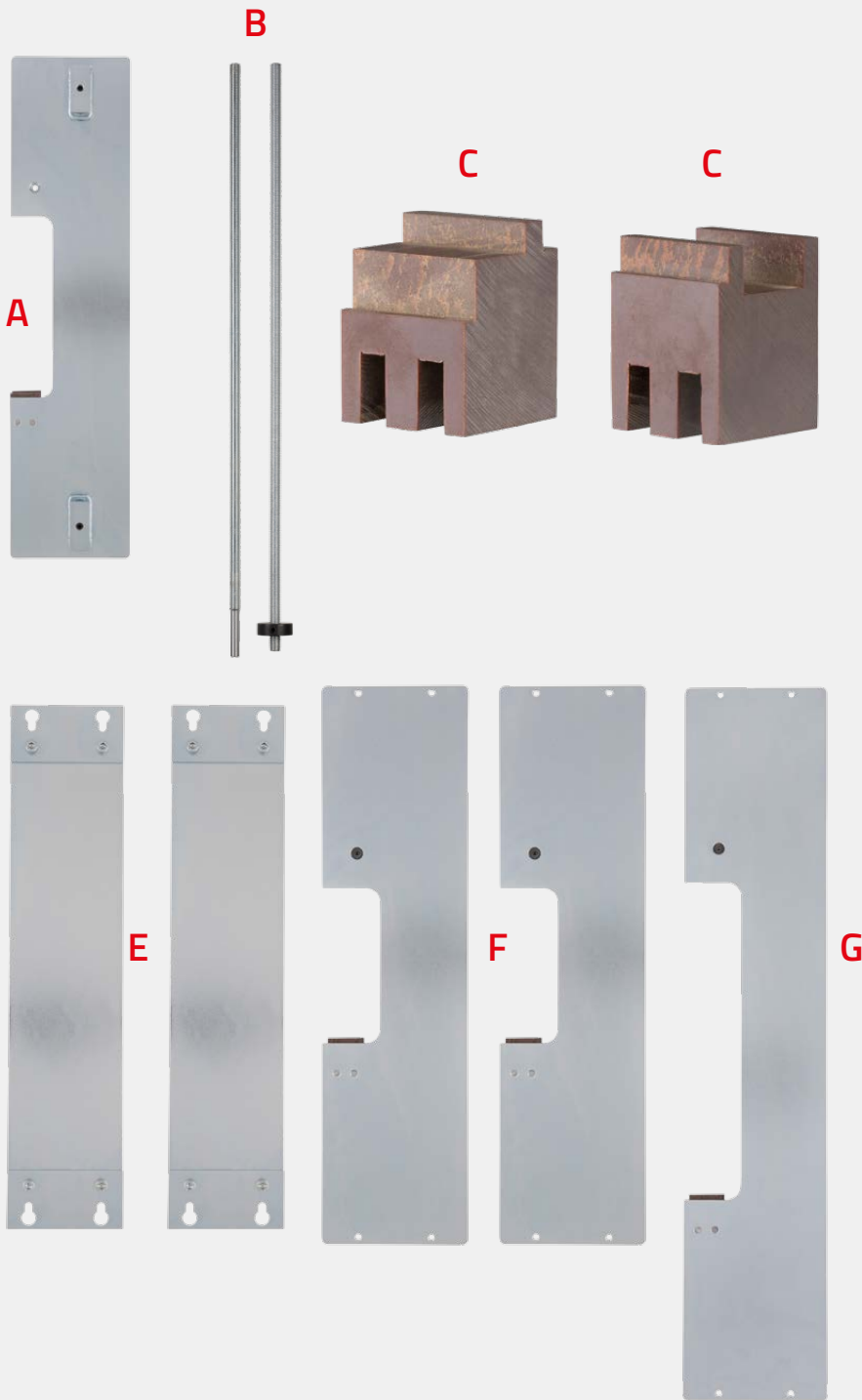

**OERTLI Werkzeuge AG**

CH-8181 Höri

T +41 44 863 75 11

info@oertli.ch

**OERTLI gereedschappenfabriek bv**

NL-4941 VP Raamsdonksveer

T +31 162 51 48 80

oertli@oertli.nl

**OERTLI Werkzeuge GmbH**

A-6800 Feldkirch

T +43 5522 75 78 70

info@oertli.at

**OERTLI Werkzeug- und  
Maschinenhandels-GmbH**

D-73486 Adelmansfelden

T +49 7963 84 19 00

info@oertli-werkzeuge.de

**OERTLI Magyarország KFT**

H-8790 Zalaszetgrot

T +36 83 56 00 05

oertlikft@t-online.hu

**OERTLI Tooling UK Ltd**

LE19 4SA

T +44 116 286 34 09

info@oertli.co.uk

**OERTLI France**

F-21000 Dijon

T +33 3 80 55 16 62

info@oertli-outils.fr

[www.oertli.com](http://www.oertli.com)